

Customer Reference	St Peters Church	QUOTATION			Today's Date	05-01-24	13:00
Job number	51179	Glazed	Supply only	Page 1 of 9			

Grace Improvements 1 Oakhill	St Peters Church The Willows Stevenage Herts	Delivery Address
SG6 2RB Tel: Fax:	Tel: Fax:	

No 1:Ali BW58mm EXT Casement Top windows **No 2:Ali BW58mm EXT Casement** Top windows **No 3:Ali BW58mm EXT Casement** Top windows **No 4:Ali BW58mm EXT Casement** Top windows

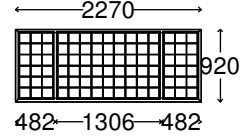
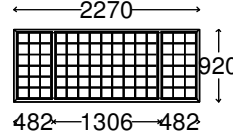
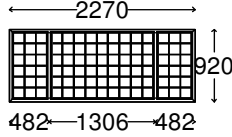
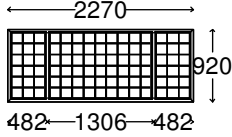

2270 x 920 Overall - 1 off

SBD, PAS24, Doc Q : No
Viewed from : Outside
Glazed in/out : Out
Mullion : AW631 57mm Slim FLUTE
Tran/Mull joints : Mechanical
Colour : Black 9005M
Bead type : AW513 28mm Bevel
Gasket Colour : Black
Furniture Colour : Black (Gloss)
Cill : None FACE DRAIN
Drainage : Face
Frame (Head) : AW604 43mm/58
Frame (Cill) : AW604 43mm/58
Frame (Left iamb) : AW604 43mm/58
Frame (Right iamb) : AW604 43mm/58
Frame Construction : Mechanical

2270 x 920 Overall - 1 off

SBD, PAS24, Doc Q : No
Viewed from : Outside
Glazed in/out : Out
Mullion : AW631 57mm Slim FLUTE
Tran/Mull joints : Mechanical
Colour : Black 9005M
Bead type : AW513 28mm Bevel
Gasket Colour : Black
Furniture Colour : Black (Gloss)
Cill : None FACE DRAIN
Drainage : Face
Frame (Head) : AW604 43mm/58
Frame (Cill) : AW604 43mm/58
Frame (Left iamb) : AW604 43mm/58
Frame (Right iamb) : AW604 43mm/58
Frame Construction : Mechanical

2270 x 920 Overall - 1 off

SBD, PAS24, Doc Q : No
Viewed from : Outside
Glazed in/out : Out
Mullion : AW631 57mm Slim FLUTE
Tran/Mull joints : Mechanical
Colour : Black 9005M
Bead type : AW513 28mm Bevel
Gasket Colour : Black
Furniture Colour : Black (Gloss)
Cill : None FACE DRAIN
Drainage : Face
Frame (Head) : AW604 43mm/58
Frame (Cill) : AW604 43mm/58
Frame (Left iamb) : AW604 43mm/58
Frame (Right iamb) : AW604 43mm/58
Frame Construction : Mechanical

2270 x 920 Overall - 1 off

SBD, PAS24, Doc Q : No
Viewed from : Outside
Glazed in/out : Out
Mullion : AW631 57mm Slim FLUTE
Tran/Mull joints : Mechanical
Colour : Black 9005M
Bead type : AW513 28mm Bevel
Gasket Colour : Black
Furniture Colour : Black (Gloss)
Cill : None FACE DRAIN
Drainage : Face
Frame (Head) : AW604 43mm/58
Frame (Cill) : AW604 43mm/58
Frame (Left iamb) : AW604 43mm/58
Frame (Right iamb) : AW604 43mm/58
Frame Construction : Mechanical

4-20-4 Clear Total + & Diamont:A Arg Blk
Thermo:Square Lead:Square Lead -
9mm-Aged lead- Oval- Std joint:..
A1 1 @ 436x 860
4-20-4 Clear Total + & Diamont:A Arg Blk
Thermo:Square Lead:Square Lead -
9mm-Aged lead- Oval- Std joint:..
D1 1 @ 1275x 860
4-20-4 Clear Total + & Diamont:A Arg Blk
Thermo:Square Lead:Square Lead -
9mm-Aged lead- Oval- Std joint:..
H1 1 @ 436x 860

4-20-4 Clear Total + & Diamont:A Arg Blk
Thermo:Square Lead:Square Lead -
9mm-Aged lead- Oval- Std joint:..
A1 1 @ 436x 860
4-20-4 Clear Total + & Diamont:A Arg Blk
Thermo:Square Lead:Square Lead -
9mm-Aged lead- Oval- Std joint:..
D1 1 @ 1275x 860
4-20-4 Clear Total + & Diamont:A Arg Blk
Thermo:Square Lead:Square Lead -
9mm-Aged lead- Oval- Std joint:..
H1 1 @ 436x 860

4-20-4 Clear Total + & Diamont:A Arg Blk
Thermo:Square Lead:Square Lead -
9mm-Aged lead- Oval- Std joint:..
A1 1 @ 436x 860
4-20-4 Clear Total + & Diamont:A Arg Blk
Thermo:Square Lead:Square Lead -
9mm-Aged lead- Oval- Std joint:..
D1 1 @ 1275x 860
4-20-4 Clear Total + & Diamont:A Arg Blk
Thermo:Square Lead:Square Lead -
9mm-Aged lead- Oval- Std joint:..
H1 1 @ 436x 860

4-20-4 Clear Total + & Diamont:A Arg Blk
Thermo:Square Lead:Square Lead -
9mm-Aged lead- Oval- Std joint:..
A1 1 @ 436x 860
4-20-4 Clear Total + & Diamont:A Arg Blk
Thermo:Square Lead:Square Lead -
9mm-Aged lead- Oval- Std joint:..
D1 1 @ 1275x 860
4-20-4 Clear Total + & Diamont:A Arg Blk
Thermo:Square Lead:Square Lead -
9mm-Aged lead- Oval- Std joint:..
H1 1 @ 436x 860

Customer Reference	St Peters Church	QUOTATION			Today's Date	05-01-24	13:00
Job number	51179	Glazed	Supply only	Page 2 of 9			

No 5:Ali BW58mm EXT Casement
Top windows

No 6:Ali BW58mm EXT Casement
Top windows

No 7:Ali BW58mm EXT Casement
Top windows

No 8:Ali BW58mm EXT Casement
Top windows

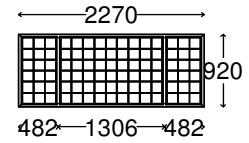
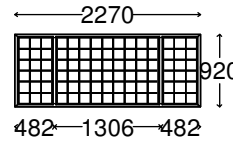
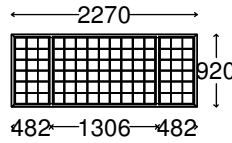
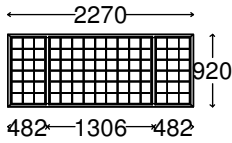

2270 x 920 Overall - 1 off

SBD, PAS24, Doc Q : No
Viewed from : Outside
Glazed in/out : Out
Mullion : AW631 57mm Slim FLUTE
Tran/Mull joints : Mechanical
Colour : Black 9005M
Bead type : AW513 28mm Bevel
Gasket Colour : Black
Furniture Colour : Black (Gloss)
Cill : None FACE DRAIN
Drainage : Face
Frame (Head) : AW604 43mm/58
Frame (Cill) : AW604 43mm/58
Frame (Left jamb) : AW604 43mm/58
Frame (Right jamb) : AW604 43mm/58
Frame Construction : Mechanical

2270 x 920 Overall - 1 off

SBD, PAS24, Doc Q : No
Viewed from : Outside
Glazed in/out : Out
Mullion : AW631 57mm Slim FLUTE
Tran/Mull joints : Mechanical
Colour : Black 9005M
Bead type : AW513 28mm Bevel
Gasket Colour : Black
Furniture Colour : Black (Gloss)
Cill : None FACE DRAIN
Drainage : Face
Frame (Head) : AW604 43mm/58
Frame (Cill) : AW604 43mm/58
Frame (Left jamb) : AW604 43mm/58
Frame (Right jamb) : AW604 43mm/58
Frame Construction : Mechanical

2270 x 920 Overall - 1 off

SBD, PAS24, Doc Q : No
Viewed from : Outside
Glazed in/out : Out
Mullion : AW631 57mm Slim FLUTE
Tran/Mull joints : Mechanical
Colour : Black 9005M
Bead type : AW513 28mm Bevel
Gasket Colour : Black
Furniture Colour : Black (Gloss)
Cill : None FACE DRAIN
Drainage : Face
Frame (Head) : AW604 43mm/58
Frame (Cill) : AW604 43mm/58
Frame (Left jamb) : AW604 43mm/58
Frame (Right jamb) : AW604 43mm/58
Frame Construction : Mechanical

2270 x 920 Overall - 1 off

SBD, PAS24, Doc Q : No
Viewed from : Outside
Glazed in/out : Out
Mullion : AW631 57mm Slim FLUTE
Tran/Mull joints : Mechanical
Colour : Black 9005M
Bead type : AW513 28mm Bevel
Gasket Colour : Black
Furniture Colour : Black (Gloss)
Cill : None FACE DRAIN
Drainage : Face
Frame (Head) : AW604 43mm/58
Frame (Cill) : AW604 43mm/58
Frame (Left jamb) : AW604 43mm/58
Frame (Right jamb) : AW604 43mm/58
Frame Construction : Mechanical

4-20-4 Clear Total + & Diamont:A Arg Blk
Thermo:Square Lead:Square Lead -
9mm-Aged lead- Oval- Std joint:..
A1 1 @ 436x 860
4-20-4 Clear Total + & Diamont:A Arg Blk
Thermo:Square Lead:Square Lead -
9mm-Aged lead- Oval- Std joint:..
D1 1 @ 1275x 860
4-20-4 Clear Total + & Diamont:A Arg Blk
Thermo:Square Lead:Square Lead -
9mm-Aged lead- Oval- Std joint:..
H1 1 @ 436x 860

4-20-4 Clear Total + & Diamont:A Arg Blk
Thermo:Square Lead:Square Lead -
9mm-Aged lead- Oval- Std joint:..
A1 1 @ 436x 860
4-20-4 Clear Total + & Diamont:A Arg Blk
Thermo:Square Lead:Square Lead -
9mm-Aged lead- Oval- Std joint:..
D1 1 @ 1275x 860
4-20-4 Clear Total + & Diamont:A Arg Blk
Thermo:Square Lead:Square Lead -
9mm-Aged lead- Oval- Std joint:..
H1 1 @ 436x 860

4-20-4 Clear Total + & Diamont:A Arg Blk
Thermo:Square Lead:Square Lead -
9mm-Aged lead- Oval- Std joint:..
A1 1 @ 436x 860
4-20-4 Clear Total + & Diamont:A Arg Blk
Thermo:Square Lead:Square Lead -
9mm-Aged lead- Oval- Std joint:..
D1 1 @ 1275x 860
4-20-4 Clear Total + & Diamont:A Arg Blk
Thermo:Square Lead:Square Lead -
9mm-Aged lead- Oval- Std joint:..
H1 1 @ 436x 860

4-20-4 Clear Total + & Diamont:A Arg Blk
Thermo:Square Lead:Square Lead -
9mm-Aged lead- Oval- Std joint:..
A1 1 @ 436x 860
4-20-4 Clear Total + & Diamont:A Arg Blk
Thermo:Square Lead:Square Lead -
9mm-Aged lead- Oval- Std joint:..
D1 1 @ 1275x 860
4-20-4 Clear Total + & Diamont:A Arg Blk
Thermo:Square Lead:Square Lead -
9mm-Aged lead- Oval- Std joint:..
H1 1 @ 436x 860

Customer Reference	St Peters Church	QUOTATION			Today's Date	05-01-24	13:00
Job number	51179	Glazed	Supply only	Page 3 of 9			

No 9:Ali BW58mm EXT Casement top windows

No 10:Ali BW58mm EXT Casement top windows

No 11:Ali BW58mm EXT Casement top windows

No 12:Ali BW58mm EXT Casement top windows

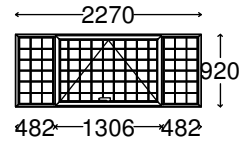
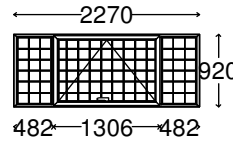
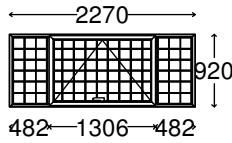
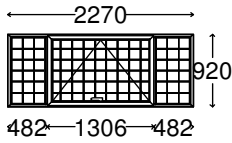

2270 x 920 Overall - 1 off

SBD, PAS24, Doc Q : No
Viewed from : Outside
Glazed in/out : Out
Mullion : AW631 57mm Slim FLUTE
Tran/Mull joints : Mechanical
Colour : Black 9005M
Sash colour : Black 9005M
Bead type : AW513 28mm Bevel
Gasket Colour : Black
Furniture Colour : Black (Gloss)
Cill : None FACE DRAIN
Drainage : Face
Frame (Head) : AW604 43mm/58
Frame (Cill) : AW604 43mm/58
Frame (Left jamb) : AW604 43mm/58
Frame (Right jamb) : AW604 43mm/58
Open in/out : Out
Frame Construction : Mechanical
[Cas] Glazed in/out : Out
[Cas] Tran/Mull joints : Mechanical
[Cas] Sash : AW614 SL Bevel
[Cas] Bead type : AW513 28mm Bevel
[Cas] Handle : NO HANDLE PREP
[Cas] Friction Stay Side : Fire only
[Cas] Friction Stay Top : Standard
[Cas] Open in/out : Out
[Cas] Casement locking : No Lock, Pre

2270 x 920 Overall - 1 off

SBD, PAS24, Doc Q : No
Viewed from : Outside
Glazed in/out : Out
Mullion : AW631 57mm Slim FLUTE
Tran/Mull joints : Mechanical
Colour : Black 9005M
Sash colour : Black 9005M
Bead type : AW513 28mm Bevel
Gasket Colour : Black
Furniture Colour : Black (Gloss)
Cill : None FACE DRAIN
Drainage : Face
Frame (Head) : AW604 43mm/58
Frame (Cill) : AW604 43mm/58
Frame (Left jamb) : AW604 43mm/58
Frame (Right jamb) : AW604 43mm/58
Open in/out : Out
Frame Construction : Mechanical
[Cas] Glazed in/out : Out
[Cas] Tran/Mull joints : Mechanical
[Cas] Sash : AW614 SL Bevel
[Cas] Bead type : AW513 28mm Bevel
[Cas] Handle : NO HANDLE PREP
[Cas] Friction Stay Side : Fire only
[Cas] Friction Stay Top : Standard
[Cas] Open in/out : Out
[Cas] Casement locking : No Lock, Pre

2270 x 920 Overall - 1 off

SBD, PAS24, Doc Q : No
Viewed from : Outside
Glazed in/out : Out
Mullion : AW631 57mm Slim FLUTE
Tran/Mull joints : Mechanical
Colour : Black 9005M
Sash colour : Black 9005M
Bead type : AW513 28mm Bevel
Gasket Colour : Black
Furniture Colour : Black (Gloss)
Cill : None FACE DRAIN
Drainage : Face
Frame (Head) : AW604 43mm/58
Frame (Cill) : AW604 43mm/58
Frame (Left jamb) : AW604 43mm/58
Frame (Right jamb) : AW604 43mm/58
Open in/out : Out
Frame Construction : Mechanical
[Cas] Glazed in/out : Out
[Cas] Tran/Mull joints : Mechanical
[Cas] Sash : AW614 SL Bevel
[Cas] Bead type : AW513 28mm Bevel
[Cas] Handle : NO HANDLE PREP
[Cas] Friction Stay Side : Fire only
[Cas] Friction Stay Top : Standard
[Cas] Open in/out : Out
[Cas] Casement locking : No Lock, Pre

2270 x 920 Overall - 1 off

SBD, PAS24, Doc Q : No
Viewed from : Outside
Glazed in/out : Out
Mullion : AW631 57mm Slim FLUTE
Tran/Mull joints : Mechanical
Colour : Black 9005M
Sash colour : Black 9005M
Bead type : AW513 28mm Bevel
Gasket Colour : Black
Furniture Colour : Black (Gloss)
Cill : None FACE DRAIN
Drainage : Face
Frame (Head) : AW604 43mm/58
Frame (Cill) : AW604 43mm/58
Frame (Left jamb) : AW604 43mm/58
Frame (Right jamb) : AW604 43mm/58
Open in/out : Out
Frame Construction : Mechanical
[Cas] Glazed in/out : Out
[Cas] Tran/Mull joints : Mechanical
[Cas] Sash : AW614 SL Bevel
[Cas] Bead type : AW513 28mm Bevel
[Cas] Handle : NO HANDLE PREP
[Cas] Friction Stay Side : Fire only
[Cas] Friction Stay Top : Standard
[Cas] Open in/out : Out
[Cas] Casement locking : No Lock, Pre

4-20-4 Clear Total + & Diamont:A Arg Blk
Thermo:Square Lead:Square Lead -
9mm-Aged lead- Oval- Std joint:..
A1 1 @ 436x 860
4-20-4 Clear Total + & Diamont:A Arg Blk
Thermo:Square Lead:Square Lead -
9mm-Aged lead- Oval- Std joint:..
D1 1 @ 1227x 812
4-20-4 Clear Total + & Diamont:A Arg Blk
Thermo:Square Lead:Square Lead -
9mm-Aged lead- Oval- Std joint:..
H1 1 @ 436x 860

4-20-4 Clear Total + & Diamont:A Arg Blk
Thermo:Square Lead:Square Lead -
9mm-Aged lead- Oval- Std joint:..
A1 1 @ 436x 860
4-20-4 Clear Total + & Diamont:A Arg Blk
Thermo:Square Lead:Square Lead -
9mm-Aged lead- Oval- Std joint:..
D1 1 @ 1227x 812
4-20-4 Clear Total + & Diamont:A Arg Blk
Thermo:Square Lead:Square Lead -
9mm-Aged lead- Oval- Std joint:..
H1 1 @ 436x 860

4-20-4 Clear Total + & Diamont:A Arg Blk
Thermo:Square Lead:Square Lead -
9mm-Aged lead- Oval- Std joint:..
A1 1 @ 436x 860
4-20-4 Clear Total + & Diamont:A Arg Blk
Thermo:Square Lead:Square Lead -
9mm-Aged lead- Oval- Std joint:..
D1 1 @ 1227x 812
4-20-4 Clear Total + & Diamont:A Arg Blk
Thermo:Square Lead:Square Lead -
9mm-Aged lead- Oval- Std joint:..
H1 1 @ 436x 860

4-20-4 Clear Total + & Diamont:A Arg Blk
Thermo:Square Lead:Square Lead -
9mm-Aged lead- Oval- Std joint:..
A1 1 @ 436x 860
4-20-4 Clear Total + & Diamont:A Arg Blk
Thermo:Square Lead:Square Lead -
9mm-Aged lead- Oval- Std joint:..
D1 1 @ 1227x 812
4-20-4 Clear Total + & Diamont:A Arg Blk
Thermo:Square Lead:Square Lead -
9mm-Aged lead- Oval- Std joint:..
H1 1 @ 436x 860

Extra Items	Quantity	Price
-------------	----------	-------

Price includes all access equipment, installation, waste removal, crank handle opening to opening windows and 10 year insurance backed guarantee.

Glazed A rating
Total Price £11,200.00 Inc Vat

This quotation includes all supply, installation, waste removal and guarantee's. Please check this quotation carefully to ensure we have quoted your requirements/specification correctly. Any ammendements to this printed quotation may effect your overall cost.
This quotation is valid for 30 days, and is subject to our standard Terms and Conditions of Sale.

Schematic Drawings

Item 1 : Ali BW58mm EXT Casement

Design Style 301
 Location Top windows
 Frame size 2270(w) x 920(h)
 Quantity 1

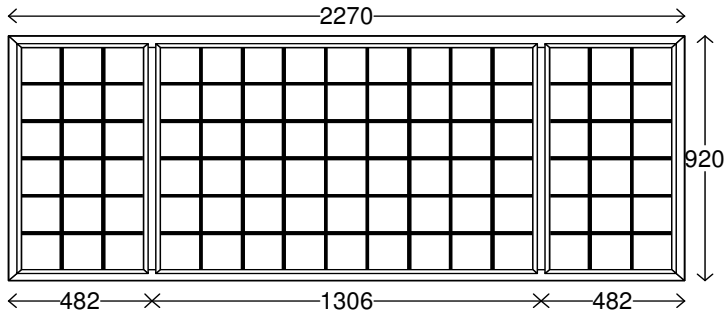
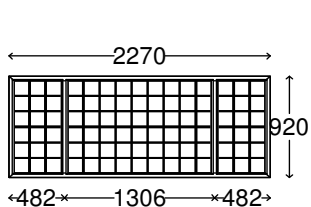

Item 2 : Ali BW58mm EXT Casement

Design Style 301
 Location Top windows
 Frame size 2270(w) x 920(h)
 Quantity 1

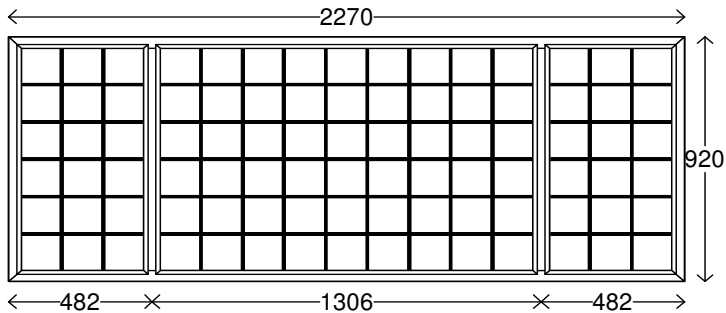
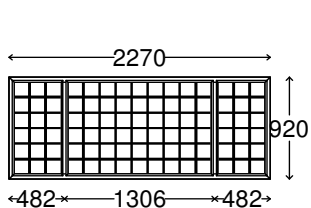

Customer Reference
Job number

St Peters Church
St Peters Church
51179

QUOTATION

Today's Date 05-01-24 13:00

Glazed

Supply only

Page 5 of 9

Item 3 : Ali BW58mm EXT Casement

Design Style 301
Location Top windows
Frame size 2270(w) x 920(h)
Quantity 1

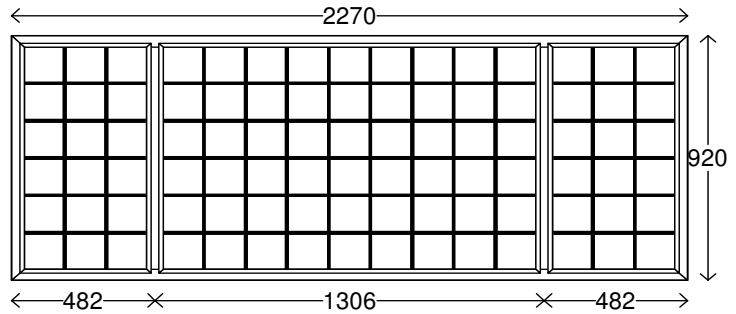
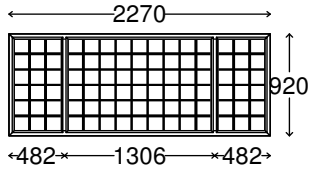

Item 4 : Ali BW58mm EXT Casement

Design Style 301
Location Top windows
Frame size 2270(w) x 920(h)
Quantity 1

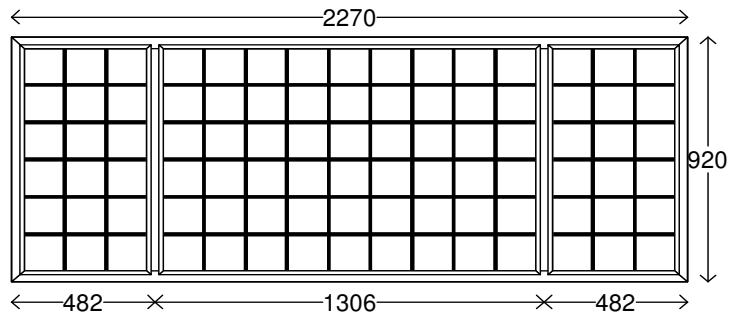
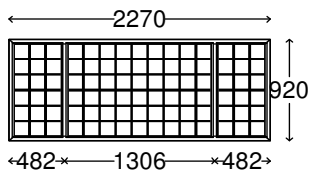

Customer Reference
Job number

St Peters Church
St Peters Church
51179

QUOTATION

Today's Date 05-01-24 13:00

Glazed

Supply only

Page 6 of 9

Item 5 : Ali BW58mm EXT Casement

Design Style 301
Location Top windows
Frame size 2270(w) x 920(h)
Quantity 1

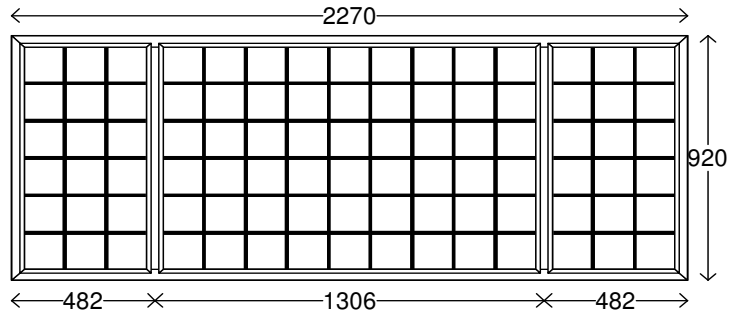
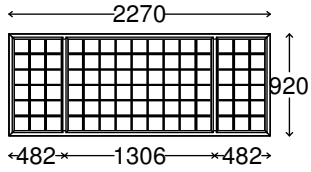

Item 6 : Ali BW58mm EXT Casement

Design Style 301
Location Top windows
Frame size 2270(w) x 920(h)
Quantity 1

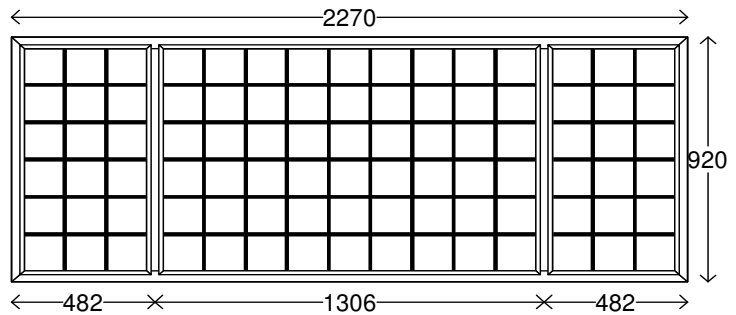
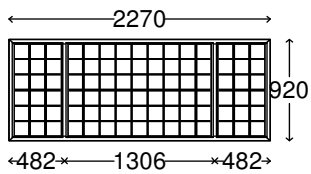

Item 7 : Ali BW58mm EXT Casement

Design Style 301
 Location Top windows
 Frame size 2270(w) x 920(h)
 Quantity 1

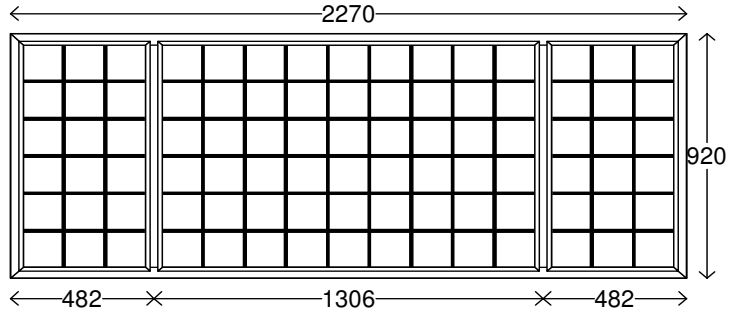
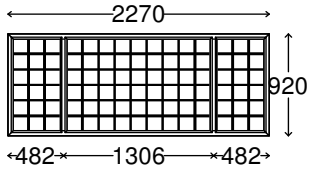

Item 8 : Ali BW58mm EXT Casement

Design Style 301
 Location Top windows
 Frame size 2270(w) x 920(h)
 Quantity 1

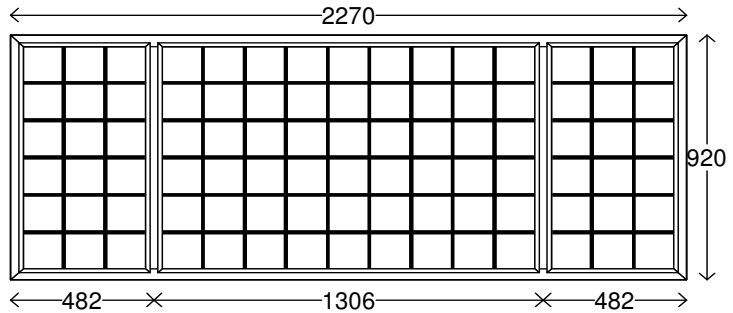
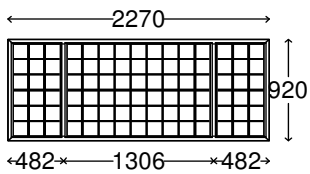

Customer
Reference
Job number

St Peters Church
St Peters Church
51179

QUOTATION

Today's Date 05-01-24 13:00

Glazed

Supply only

Page 8 of 9

Item 9 : Ali BW58mm EXT Casement

Design Style 302
Location top windows
Frame size 2270(w) x 920(h)
Quantity 1

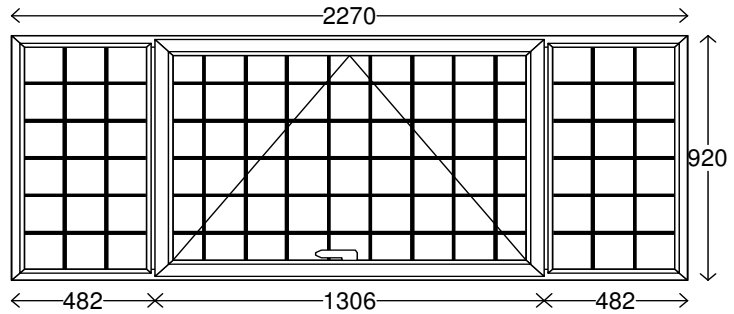
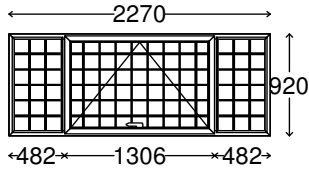

Item 10 : Ali BW58mm EXT Casement

Design Style 302
Location top windows
Frame size 2270(w) x 920(h)
Quantity 1

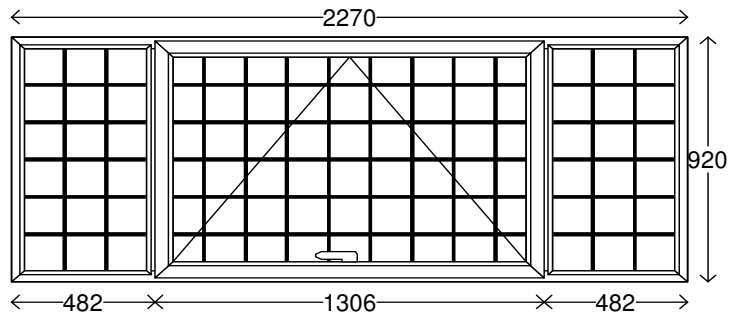
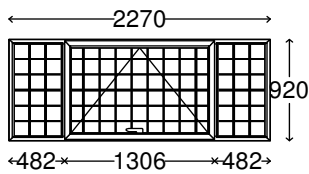

Customer Reference
Job number

St Peters Church
St Peters Church
51179

QUOTATION

Today's Date 05-01-24 13:00

Glazed

Supply only

Page 9 of 9

Item 11 : Ali BW58mm EXT Casement

Design Style 302
Location top windows
Frame size 2270(w) x 920(h)
Quantity 1

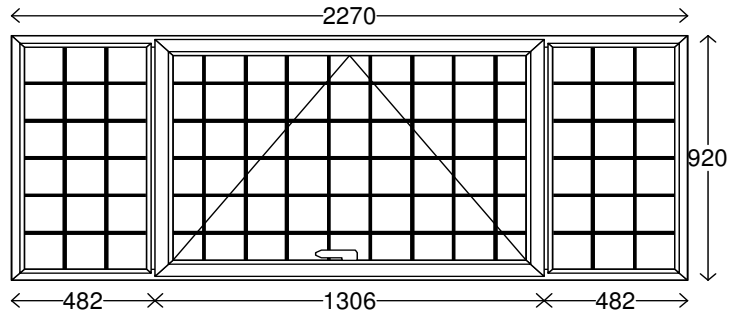
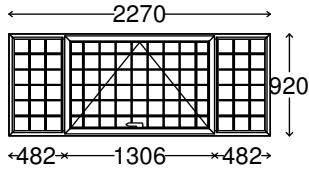

Item 12 : Ali BW58mm EXT Casement

Design Style 302
Location top windows
Frame size 2270(w) x 920(h)
Quantity 1

